

HAKI Public Access Stair

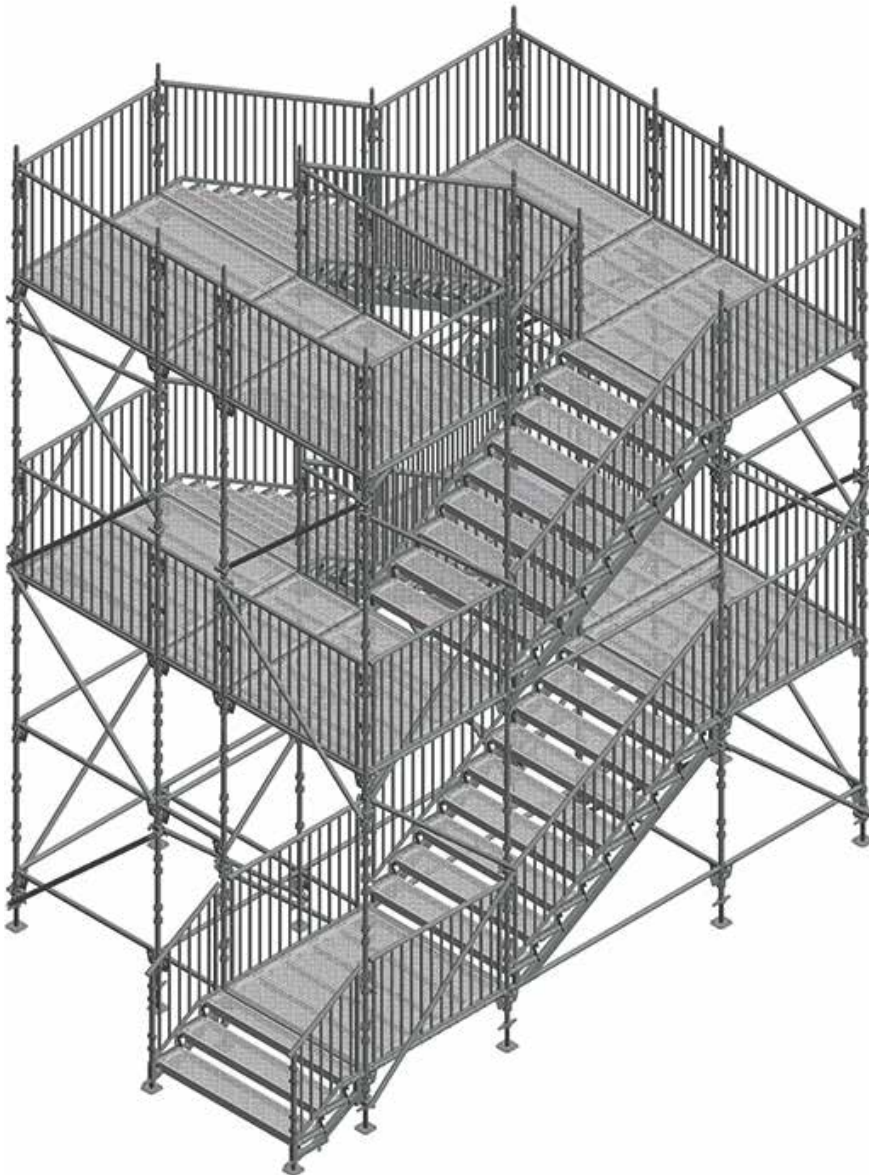

Alt. use of Stair stringer entrance 3 step (7102006) and Stair handrail 1655x500 (7058050).

The **HAKI Public Access Stair** system is the solution for every situation, providing guaranteed safety and maximum adaptability.

The HAKI Public Staircase system is based on HAKI Universal scaffolding components supplemented by a number of carefully designed parts.

The rise/going relationship is 167/280 mm, giving a stair slope of 31° for best comfort and complies with strict British Building regulations for public use.

The largest opening between treads, in stair and landing handrails and in guardrails does not allow the passage of a sphere of 100 mm or more in diameter.

Handrails are adjustable in height for different types of decking.

A unique locking system for stair stringers and handrails provides the highest level of safety and security.

Components

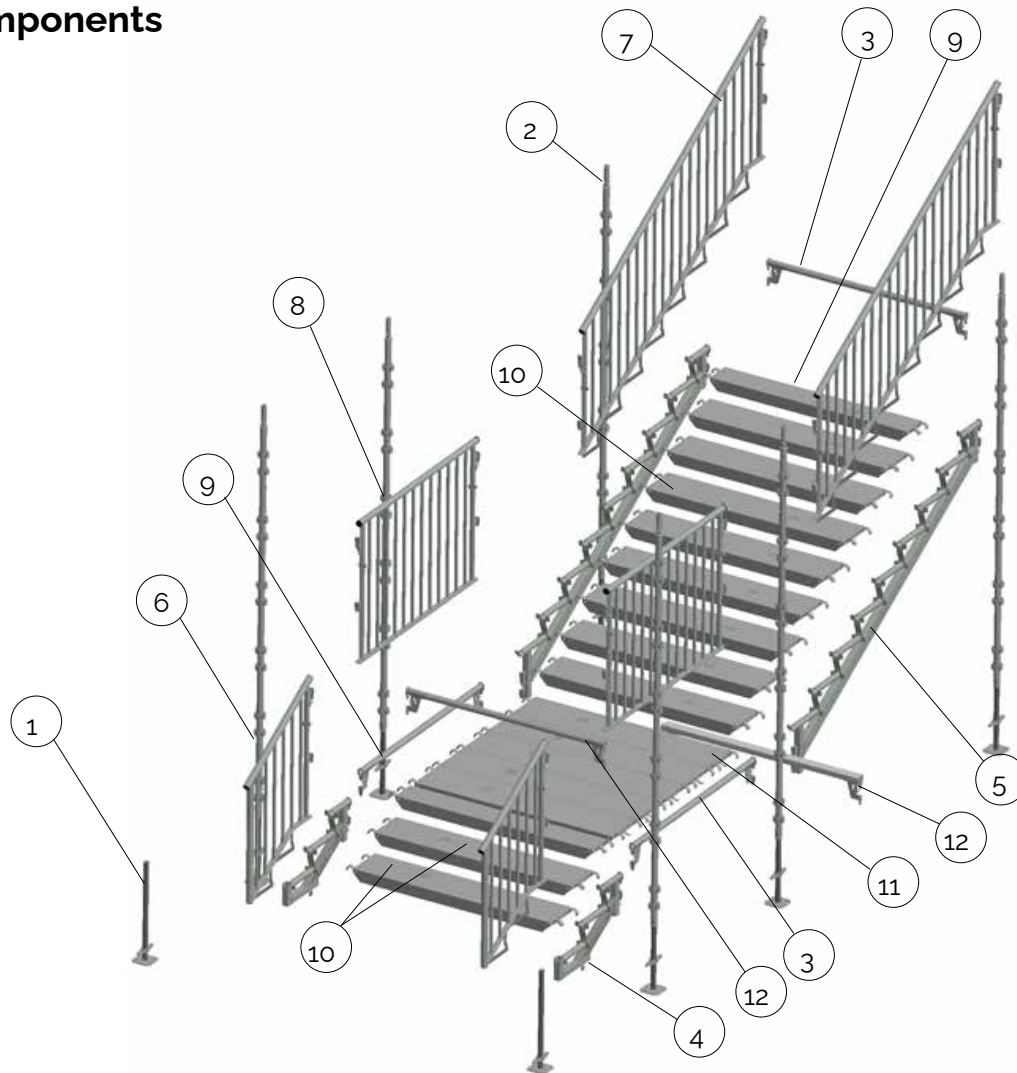

Nr	Art. no.	Name	Weight [kg]
1	2071000	Base jack BS	5.0
2	7016300	Standard S 3000	15.2
3	7022161	Single tube beam ERB 1655	6.3
4	7102006	Stair stringer entrance 3 step	10.7
	7102100	Stair stringer 1655x1000	24.0
5	7102150	Stair stringer 2500x1500	34.5
6	7058004	Stair handrail entrance 3 step	15.0
	7058050	Stair handrail 1655x500	24.0
	7058100	Stair handrail 1655x1000	26.5
7	7058152	Stair handrail 2500x1500	36.5
	7053030	Handrail 1100/300	7.2
	7053077	Handrail 1100/770	12.5
	7053125	Handrail 1100/1250	17.5
8	7053165	Handrail 1100/1655	23.0
	7053191	Handrail 1100/1964	28.7
	7053250	Handrail 1100/2500	34.1
9	2153165	AL plank ALP 1655x200x90 AL	6.2 ¹⁾
10	2153164	AL plank ALP 1655x295x90 AL	7.5 ¹⁾
11	2153163	AL plank ALP 1655x320x90 AL	7.9 ¹⁾

Comment: AL plank ALP Length = 1655 – Load class 6 (6.0 kN/m²).

¹⁾ Also available in 1250 and 1964

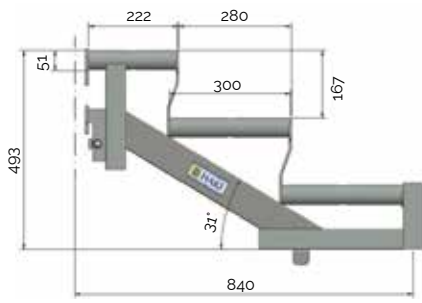

7102006 Stair stringer entrance 3 step 10.7 kg

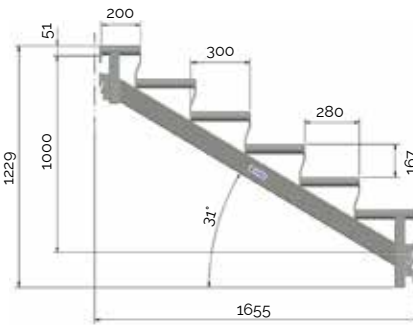

7102100 Stair stringer 1655x1000 24.0 kg

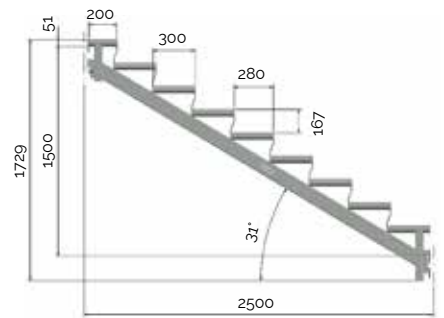

7102150 Stair stringer 2500x1500 34.5 kg

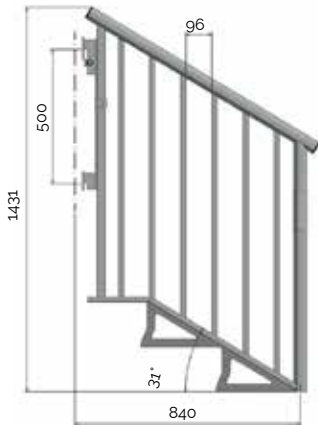

7058004 Stair handrail entrance 3 15.0 kg

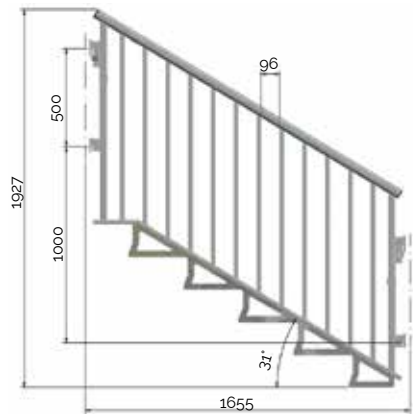

7058100 Stair handrail 1655x1000 26.5 kg

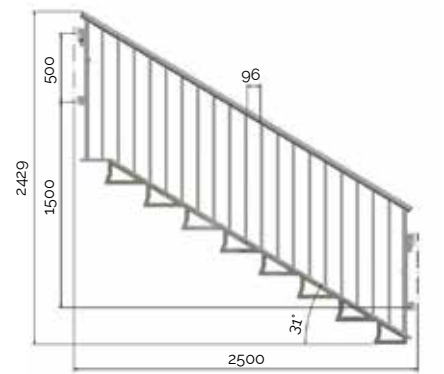

7058152 Stair handrail 2500x1500 36.5 kg

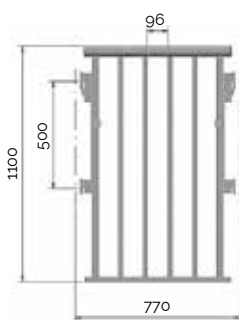

7053077 Handrail 1100/770 12.5 kg

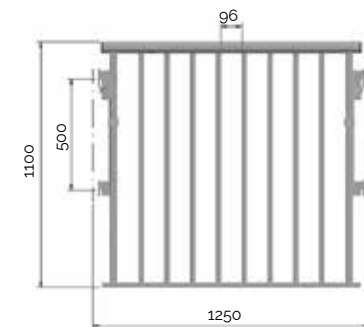

7053125 Handrail 1100/1250 17.5 kg

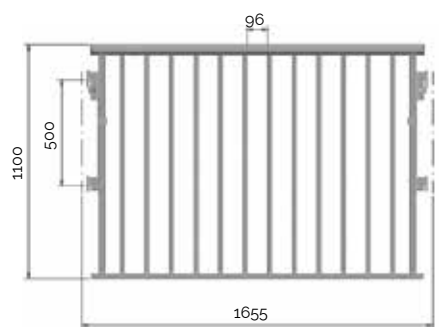

7053165 Handrail 1100/1655 23.0 kg

Permissible loads for stair stringer 2500x1500

Tread length [mm]	Permissible load one side [kN/m ²]	Permissible load two sides [kN/m ²]
770	16.1	8.1
1050	11.8	5.9
1250	9.9	5.0
1655	7.5	3.8
1964	6.3	3.2
2500	5.0	2.5

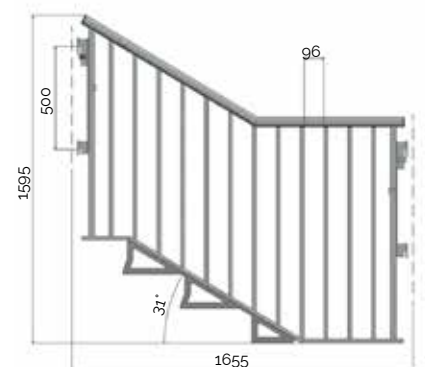

7058050 Stair handrail 1655x500 24.0 kg

The stringers are designed for a permissible load of 7.5 kN/m² for a tread length of 1655 mm and loading from one side. However, permissible loads are limited by the decking used.

For other loads, please contact HAKI's technical department.

Bracing and tying-in

Bracing and tying-in should be carried out according to the current design drawing.

Normally every standard on one side of the staircase should be tied at each 4m in height.

Use plan brace to ensure that the staircase in every bay is square.

Applications

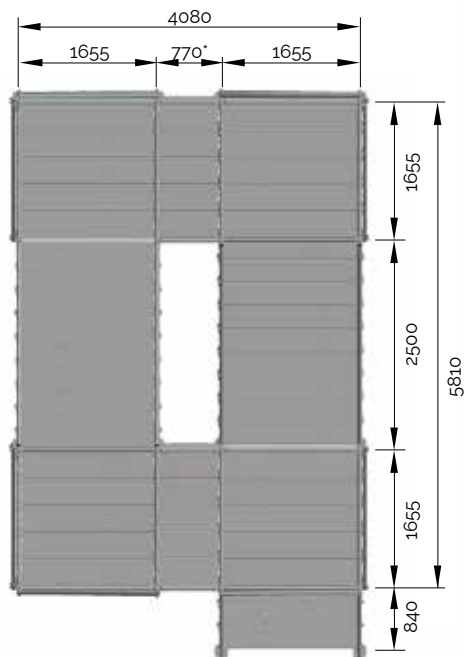

) other sizes may be incorporated

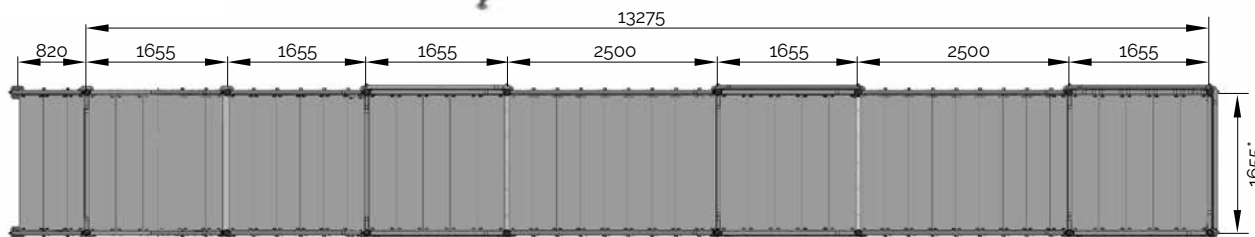
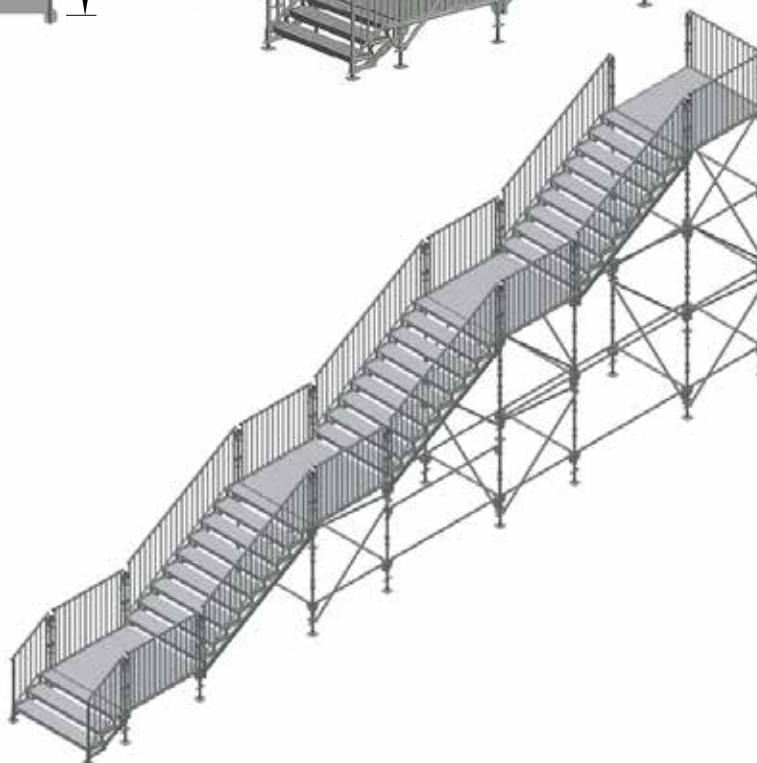
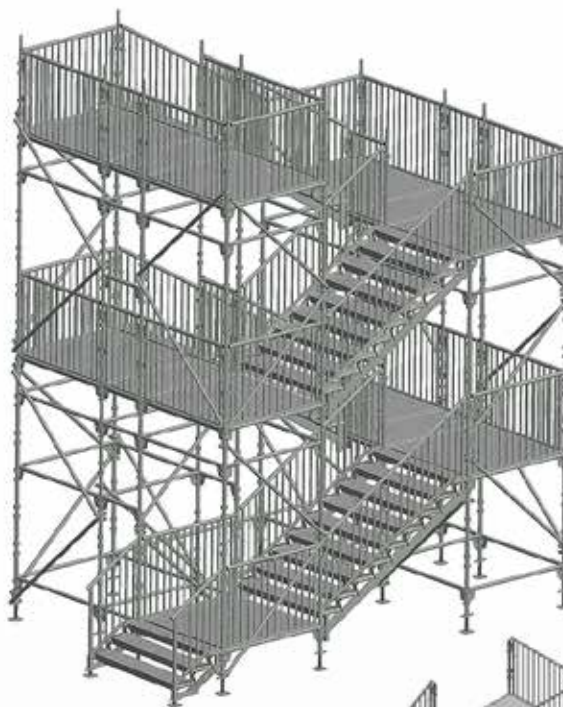

) Also available in 1250 and 1964

